

Herrajes

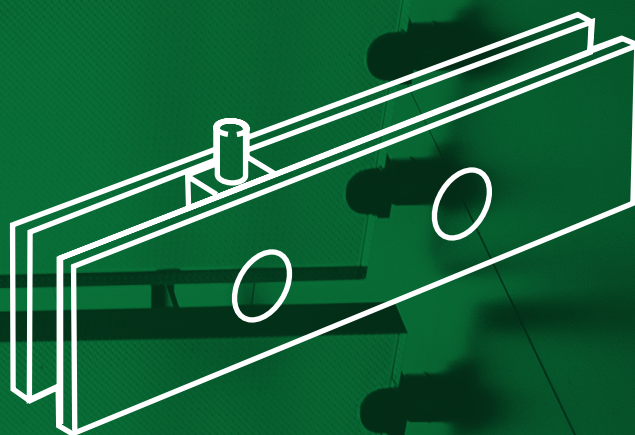
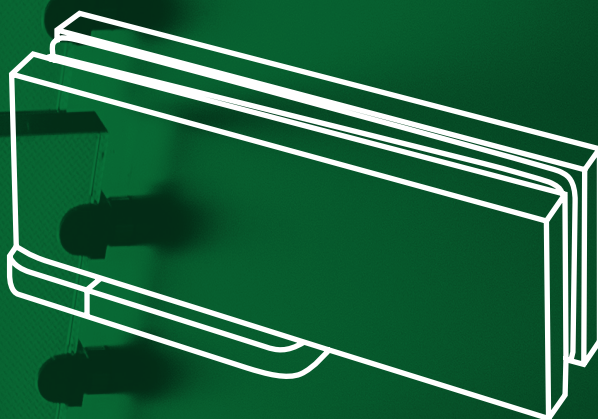
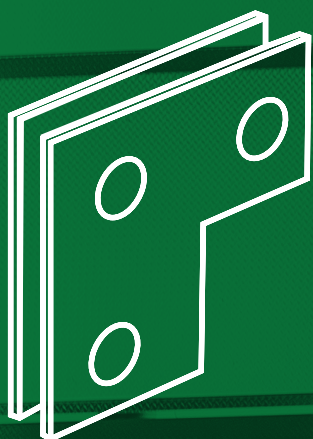

| | |
|--------------------------------|-------|
| 2.1 - SECURIT..... | 22-23 |
| 2.2 - PERNIOS HIDRÁULICOS..... | 24-25 |

SERIE SECURUS

Vidrio 10 mm

AISI-304

PERNIO ALTO

160 x 37 mm

Medida máxima puerta: 2500 x 1100 mm

Peso máximo de la puerta: 70 kg

Acabados:

| | |
|-------------|----------------|
| Inox brillo | 7140 IB |
| Inox mate | 7140 IM |

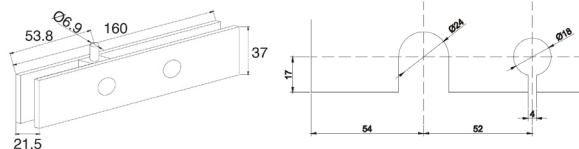

PERNIO BAJO REGLETA

160 x 44 mm

Acabados:

| | |
|-------------|----------------|
| Inox brillo | 7141 IB |
| Inox mate | 7141 IM |

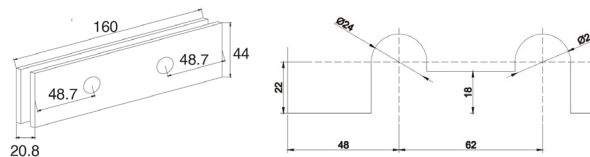

PUNTO DE GIRO

Acabados:

| | |
|-------------|----------------|
| Inox brillo | 7168 IB |
| Inox mate | 7168 IM |

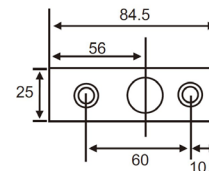

PUNTO DE GIRO MONTANTE

160 x 40 mm

Acabados:

| | |
|-------------|----------------|
| Inox brillo | 7160 IB |
| Inox mate | 7160 IM |

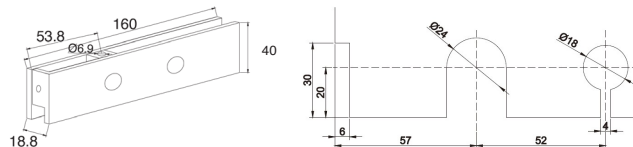
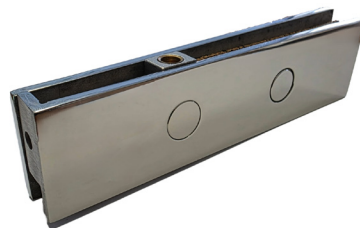

PUNTO DE GIRO LATERAL MONTANTE

202 x 80 mm

Acabados:

| | |
|-------------|----------------|
| Inox brillo | 7165 IB |
| Inox mate | 7165 IM |

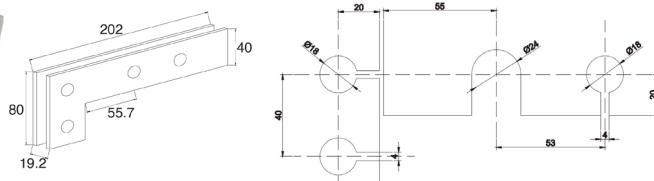

FIJO 1 LUNA

40 x 40 mm

Acabados:

| | |
|-------------|----------------|
| Inox brillo | 7172 IB |
| Inox mate | 7172 IM |

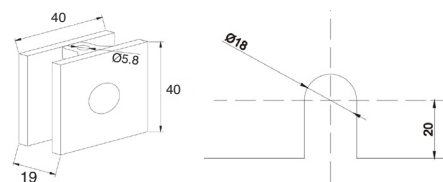

UNIÓN 3 LUNAS

80 x 80 mm

Acabados:

| | |
|-------------|----------------|
| Inox brillo | 7184 IB |
| Inox mate | 7184 IM |

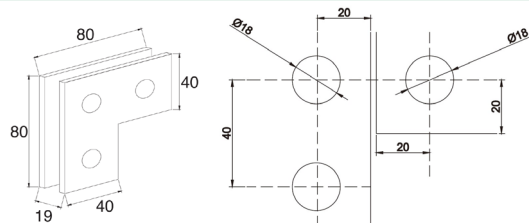

SERIE NEXUS

Vidrio 8 a 13 mm

AISI-304

KIT DE PERNIO HIDRÁULICO

Características técnicas:

- Kit compuesto por: pernio alto, pernio bajo hidráulico y punto de giro superior
- Mecanismo provisto de dos velocidades de cierre.
 - 1ª velocidad: de aproximación, actúa de 150° a 10°.
 - 2ª velocidad: de cierre, actúa de 10° a 0°.
- Ancho máximo de la puerta 1000 mm.
- Peso máximo aconsejable de la puerta 100 kg.
- Retención a 90°
- Certificado Grado 3 (anticorrosión)

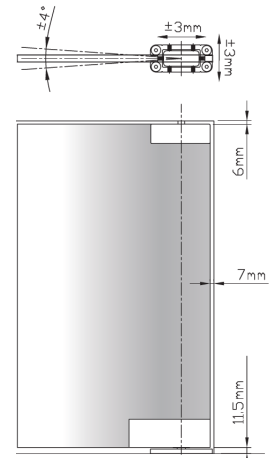

Acabados:

| | |
|-------------|----------------|
| Inox brillo | 7752 IB |
| Inox mate | 7752 IM |
| Negro mate | 7752 NE |



* Acabados especiales bajo pedido

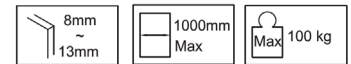

PERNIO ALTO

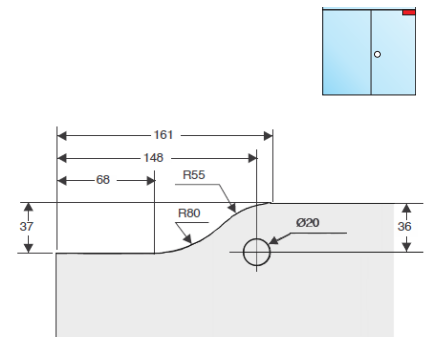
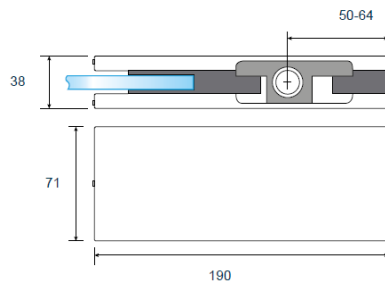

PERNIO BAJO HIDRÁULICO

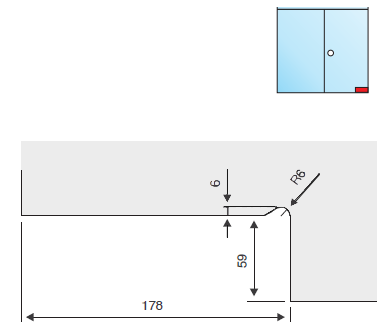
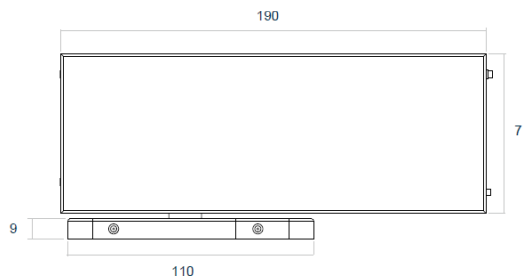

PUNTO DE GIRO SUPERIOR

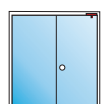

COMPONENTES SERIE NEXUS
PERNIO - FRENO INFERIOR
Acabados:

| | |
|-------------|----------------|
| Inox brillo | 7753 IB |
| Inox mate | 7753 IM |

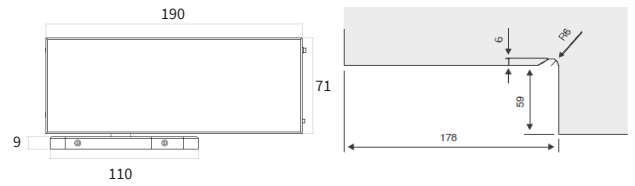
PERNIO ALTO
Acabados:

| | |
|-------------|------------------|
| Inox brillo | 7140.T IB |
| Inox mate | 7140.T IM |

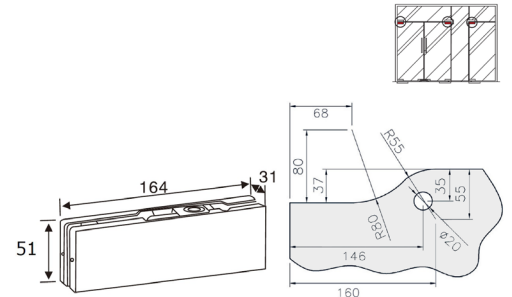
PUNTO DE GIRO MONTANTE
Acabados:

| | |
|-------------|------------------|
| Inox brillo | 7160.T IB |
| Inox mate | 7160.T IM |

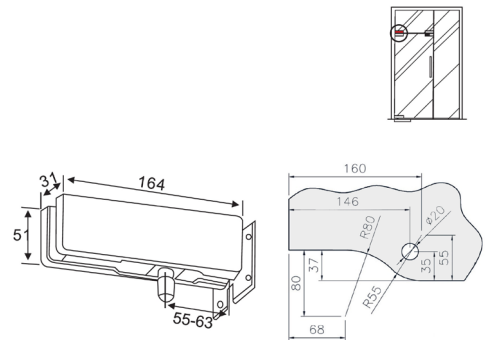
PUNTO DE GIRO LATERAL MONTANTE
Acabados:

| | |
|-------------|------------------|
| Inox brillo | 7165.T IB |
| Inox mate | 7165.T IM |

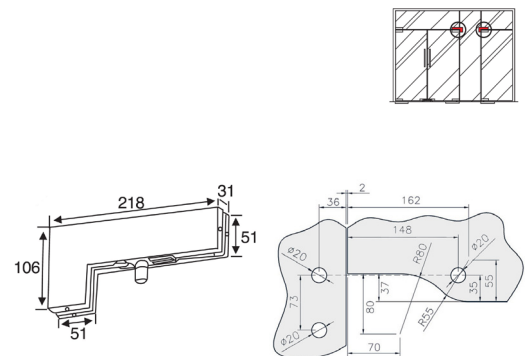
UNIÓN TRES LUNAS
Acabados:

| | |
|-------------|------------------|
| Inox brillo | 7184.T IB |
| Inox mate | 7184.T IM |

